

3500-4300-8500-9555 Specialty Glass Measuring Instructions

Claim Number _____

3500 Series

4300 Series

8500 Series

9555 Series

****ALL INFORMATION IS REQUIRED. INSUFFICIENT OR INCOMPLETE FORMS WILL DELAY THE PROCESS****

TO ORDER GLASS PANEL: (see other form)

Please measure and give the actual vision area only.
(Do not include glazing bead with measurements)

Replacement glass will be made 1" larger than vision area in width and height.

Color:

- White
- Almond

Grids:

- Yes—Please draw grid pattern in area provided
- No

Grid Style:

- 5/8" Flat 11/16" Sculptured
- 7/8" Flat 15/16" Sculptured

Warranty only covers the original purchaser of the product. Please include proof you are the original owner with a copy of closing papers or receipt of purchase.

Name _____

Street Address _____

City _____ ST _____ Zip _____

Phone Number _____

Email _____

Reason for Claim _____

Month, Date, Year of Product Manufactured: _____ (MM) _____ (DD) _____ (YY)

****Must provide proof of purchase****

Glass Options: Check (✓) all that apply

- Clear Double Pane
- Low E/Argon
- Tempered
- Obscured

***If you would like to upgrade your glass options see below for pricing**

Note: Circle-Top/Eyebrow/Arch-Top/Extended Circle-Top Windows

It is the responsibility of the purchaser to specify the correct replacement glass type in accordance with any and all applicable buildings codes. (i.e. safety glass near doorways, bathrooms, etc.)

*** Different sizes must be on separate forms. Please make copies.**

*** Discrepancies must be reported within 60 days.**

Glass is no charge per warranty; however, shipping charges do apply and must be prepaid. Please see below for shipping charges.

Credit Card # _____

Exp. Date _____ CVV _____



Check One: (width + height = ui)

- Send replacement glass at no charge per warranty

Shipping Charges:

- \$45.00 per panel (Up to 86 ui) width + height = ui
- \$180.00 per panel (Over 86 ui) width + height = ui + \$100.00 for each additional glass/panel

*** Make check payable to MI Windows and Doors, Inc.**

Glass Option Upgrade Costs: (Charges Only Applicable If Upgrading Glass)

- LowE/Argon or Obscured Glass—\$80.00 per panel
- Adding Grids between the glass up to 86 ui—\$75.00 per panel
- Adding Grids between the glass over 86 ui—\$150.00 per panel
- Tempered Glass up to 86 ui—\$50.00 per panel
- Tempered Glass over 86 ui—\$100.00 per panel

Only use this section if you currently do not have these options.

****ALL INFORMATION IS REQUIRED. INSUFFICIENT OR INCOMPLETE FORMS WILL DELAY THE PROCESS****

WINDOWS VIEWED FROM INSIDE

Eyebrow

Quantity: _____

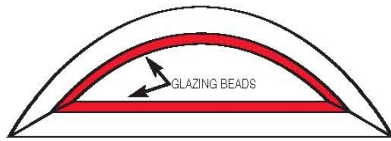

Glass Vision Width: _____

Glass Vision Height: _____

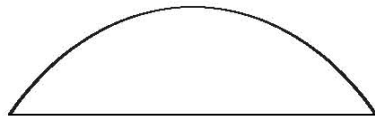
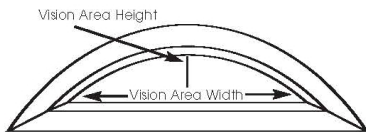

Draw Grid Pattern Above

Circle Top

Quantity: _____

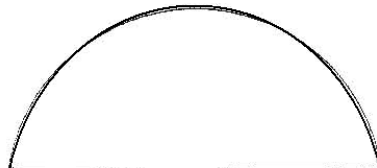
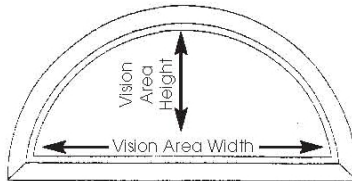
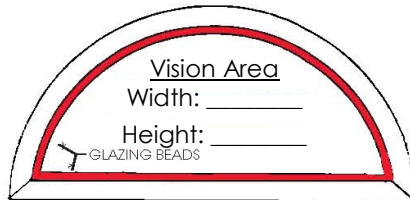

Draw Grid Pattern Above

Arch-Top

Quantity: _____

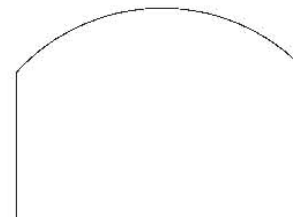
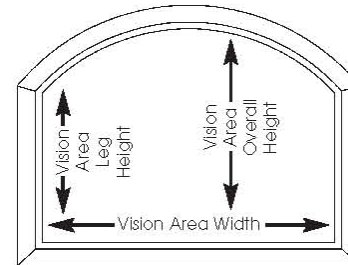
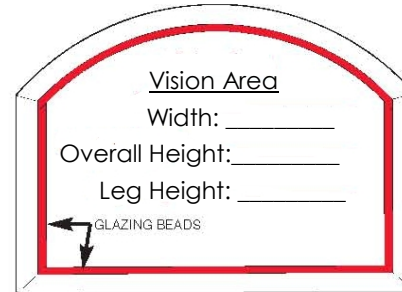

Draw Grid Pattern Above

Extended Circle-Top

Quantity: _____

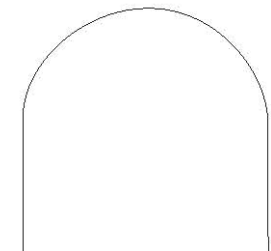
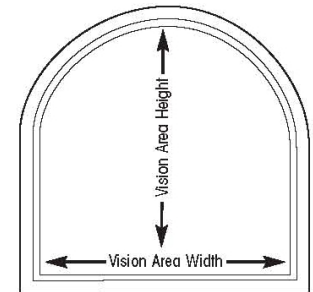
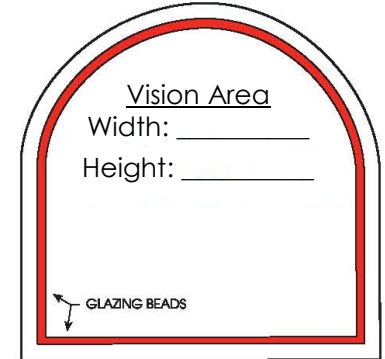

Draw Grid Pattern Above

****Please enclose pictures of your window above, along with the form and payment****

PLEASE CHECK IF THE GRIDS ALIGN ABOVE ONE OF THE FOLLOWING:

- Picture Window
- Triple Window
- Single Window
- Stand Alone
- Twin Window

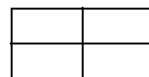
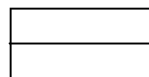
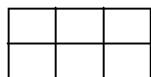

Fixed Glass Replacement Instructions

Preparation For New Glass Panel

1. Remove glazing bead pieces which hold the top glass into place by inserting a standard screwdriver and twisting as shown. After bead is loose pull out fully. Save these pieces for new glass re-installation. (CAUTION: the glass panel may be loose when removing glazing bead).
2. With a utility knife, carefully cut, as shown, along broken glass on four (4) sides until it is free from the main frame and meeting rail.
3. Clean window main frame and meeting rail of glass and sealant to obtain a clean surface for the new glass panel. Save the vinyl setting block for re-installation.

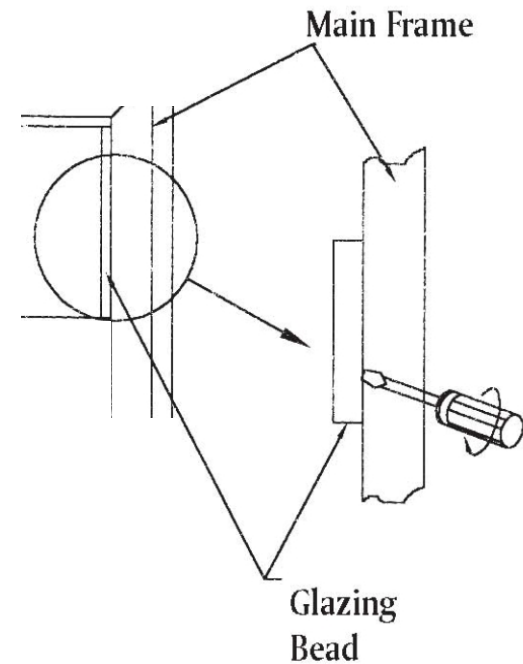

Installation of New Glass Panel

4. Determine proper orientation of the glass panel in the main frame. Replace the vinyl setting blocks on the meeting rail. Remove the backing from the sealant on the glass to expose sealant. Carefully place glass panel on the main frame, allow the panel to rest on the setting blocks.
5. With wooden block and mallet, tap glazing beads into slot in main frame and meeting rail on all four (4) sides to hold glass panel in place. Do horizontal pieces first.

